

TERAPIA GENICA

Molecular genetics of human diseases:

Gene therapy

The term *gene therapy* describes any procedure intended to treat or alleviate disease by genetically modifying the cells of a patient. It encompasses many different strategies and the material transferred into patient cells may be genes, gene segments or oligonucleotides. The genetic material may be transferred directly into cells within a patient (*in vivo* gene therapy), or cells may be removed from the patient and the genetic material inserted into them *in vitro*, prior to transplanting the modified cells back into the patient (*ex vivo* gene therapy). Because the molecular basis of diseases can vary widely, some gene therapy strategies are particularly suited to certain types of disorder, and some to others. Major disease classes include:

- *infectious diseases* (as a result of infection by a virus or bacterial pathogen);
- *cancers* (inappropriate continuation of cell division and cell proliferation as a result of activation of an oncogene or inactivation of a tumor suppressor gene or an apoptosis gene);
- *inherited disorders* (genetic deficiency of an individual gene product or genetically determined inappropriate expression of a gene);
- *immune system disorders* (includes allergies, inflammations and also autoimmune diseases, in which body cells are inappropriately destroyed by immune system cells).

A major motivation for gene therapy has been the need to develop novel treatments for diseases for which there is no effective conventional treatment. Gene therapy has the potential to treat all of the above classes of disorder. Depending on the basis of pathogenesis, different gene therapy strategies can be considered. One, rather arbitrary, subdivision of gene therapy approaches is as follows:

- *Classical gene therapy*. The rationale of this type of approach is to deliver genes to appropriate target cells with the aim of obtaining optimal expression of the introduced genes. Once inside the desired cells in the patient, the expressed genes are intended to do one of the following:
 - a. produce a product that the patient lacks;
 - b. kill diseased cells directly, e.g. by producing a toxin which kills the cells;
 - c. activate cells of the immune system so as to aid killing of diseased cells.
- *Nonclassical gene therapy*. The idea here is to inhibit the expression of genes associated with the pathogenesis, or to correct a genetic defect and so restore normal gene expression.

Current gene therapy is exclusively *somatic* gene therapy, the introduction of genes into somatic cells of an affected individual. The prospect of human germline gene therapy raises a number of ethical concerns, and is currently not sanctioned.

Molecular genetics of human diseases: Gene therapy

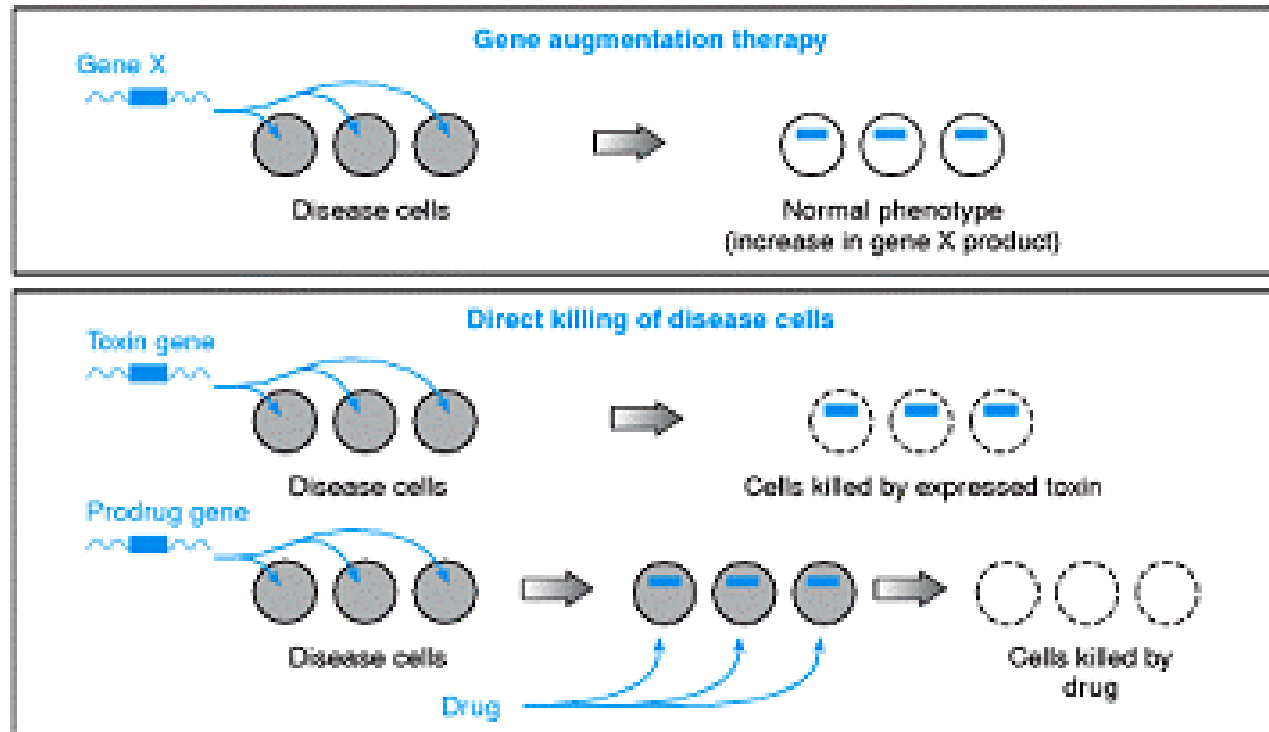

Five approaches to gene therapy. Of the five illustrated approaches, four have been used in clinical trials. Gene augmentation therapy by simple addition of functional alleles has been used to treat several inherited disorders caused by genetic deficiency of a gene product. Artificial cell killing and immune system-assisted cell killing have been popular in the treatment of cancers. The former has involved transfer to cells of genes encoding toxic compounds (**suicide genes**), or **prodrugs** (reagents which confer sensitivity to subsequent treatment with a drug). ODN, oligodeoxynucleotide; TFO, triplex-forming oligonucleotide.

Molecular genetics of human diseases: Gene therapy

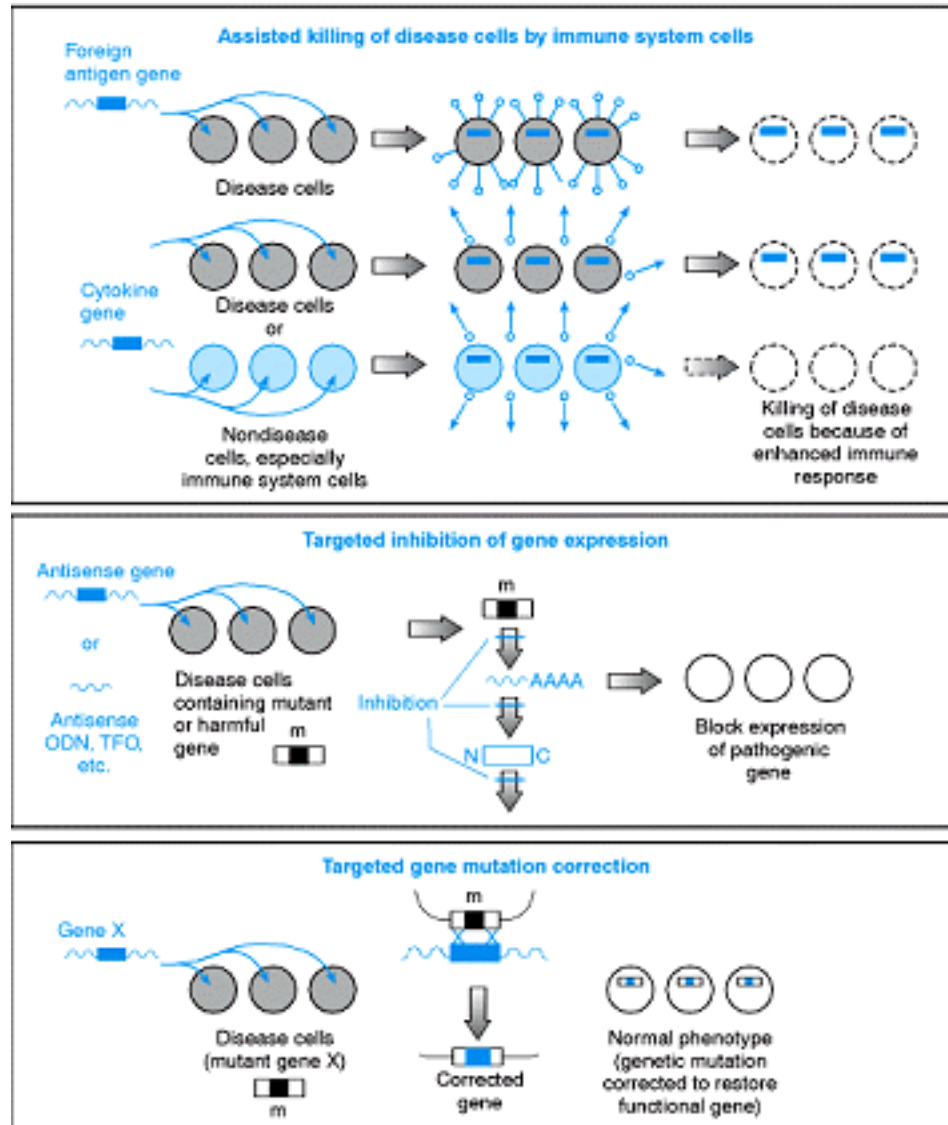

Five approaches to gene therapy.

Artificial cell killing and immune system-assisted cell killing have been popular in the treatment of cancers. The former has involved transfer to cells of genes encoding toxic compounds (**suicide genes**), or **prodrugs** (reagents which confer sensitivity to subsequent treatment with a drug). Targeted inhibition of gene expression is particularly suitable for treating infectious diseases and some cancers. Targeted gene mutation correction, the repair of a genetic defect to restore a functional allele, is the exception: technical difficulties have meant that it is not sufficiently reliable to warrant clinical trials. The example shows correction of a mutation in a mutant gene by **homologous recombination**, but mutation correction may also be possible at the RNA level. ODN, oligodeoxynucleotide; TFO, triplex-forming oligonucleotide.

Molecular genetics of human diseases: Gene therapy

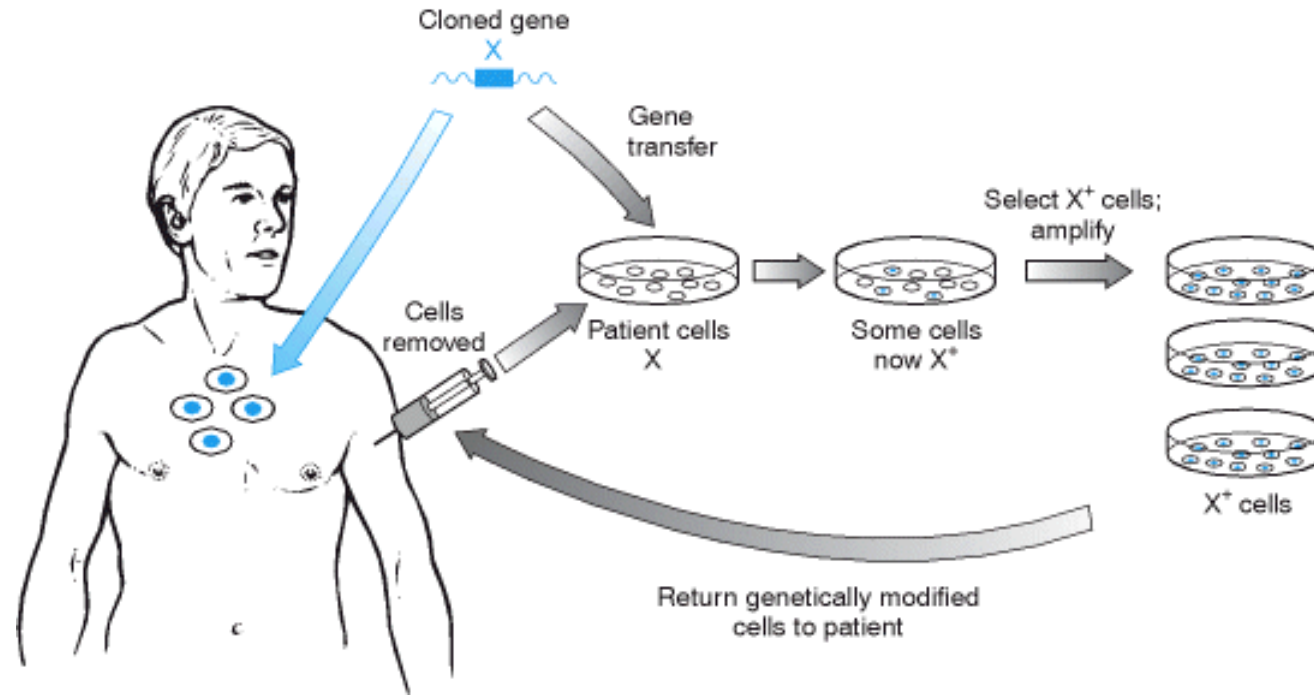
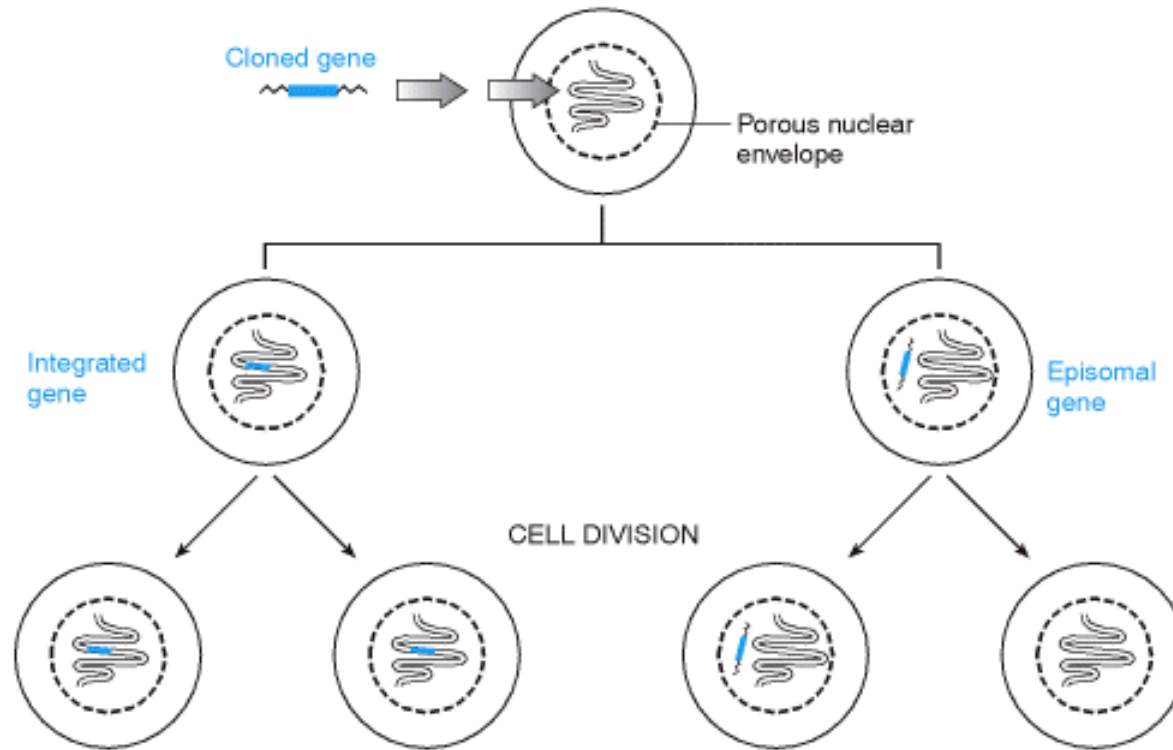

Figure 22.3. *In vivo* and *ex vivo* gene therapy. *In vivo* gene therapy (blue arrow) entails the genetic modification of the cells of a patient *in situ*. *Ex vivo* gene therapy (black arrows) means that cells are modified outside the body before being implanted into the patient. The figure shows the usual situation where autologous cells are used, i.e. cells are removed from the patient, cultured *in vitro*, before being returned to the patient. Occasionally, however, the cells that are implanted do not belong to the patient but are allogeneic (from another human source) in which case HLA matching is routinely required to avoid immune rejection.

Molecular genetics of human diseases: Gene therapy



Exogenous genes that integrate into chromosomes can be stably transmitted to all daughter cells, unlike episomal (extrachromosomal) genes. The figure illustrates two possible fates of genes that have been transferred into nucleated cells. If the cells are actively dividing, any genes which integrate stably into chromosomal DNA can be replicated under the control of the parent chromosome (during the S phase of the cell cycle). Following each cell division, an integrated gene will be stably inherited by both daughter cells. As a result, all cells that descend from a single cell in which stable integration took place, will contain the integrated gene. Gene therapy involving chromosomal integration of exogenous genes offers the possibility of continued stable expression of the inserted gene and a permanent cure, but carries certain risks, notably the possibility that one of the integration events may result in cancer. By contrast, episomal genes which do not integrate but replicate extrachromosomally (under the control of a vector origin of replication) may not segregate to all daughter cells during subsequent mitoses. As a result, this type of approach has been particularly applied in gene therapies where the target tissue consists of nondividing cells.

Molecular genetics of human diseases: Gene therapy

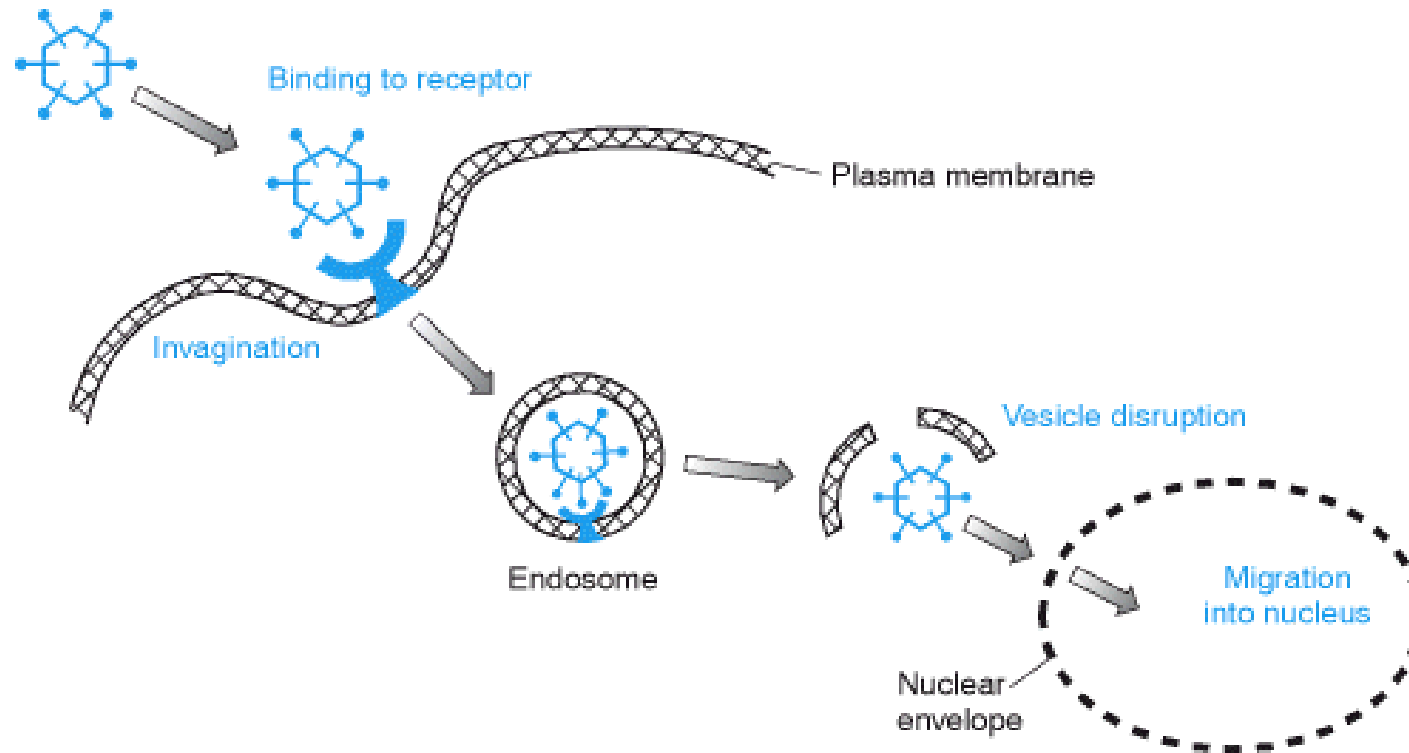

Adenoviruses enter cells by receptor-mediated endocytosis. Binding of viral coat protein to a specific receptor on the plasma membrane of cells is followed by **endocytosis**, a process in which the plasma membrane invaginates and then pinches off to form an intracellular vesicle (**endosome**). Subsequent vesicle disruption by adenovirus proteins allows virions to escape and migrate towards the nucleus where viral DNA enters through pores in the nuclear envelope.

Molecular genetics of human diseases: Gene therapy

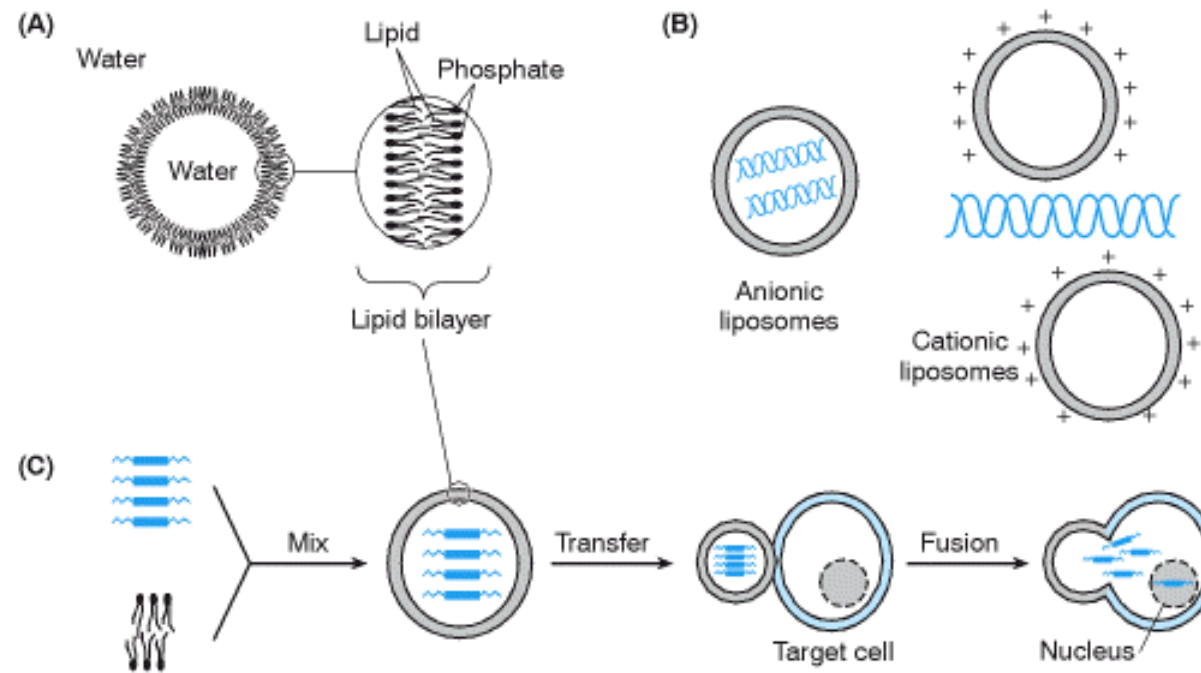

In vivo liposome gene delivery. (A) and (B) Structure of liposomes. Liposomes are synthetic vesicles which can form spontaneously in aqueous solution following artificial mixing of lipid molecules. In some cases, a phospholipid bilayer is formed, with hydrophilic phosphate groups located on the external surfaces and hydrophobic lipids located internally (left). In other cases there is a multilamellar lipid envelope. Anionic liposomes have a negative surface charge and when the lipid constituents are mixed with negatively charged DNA molecules (see panel C below), the DNA is internalized. Cationic liposomes have a surface positive charge and DNA molecules bind to the surface of liposomes. (C) Use of liposomes to transfer genes into cells. This figure illustrates the use of anionic liposomes to transfer internally located DNA into cells. The plasma membranes of cells are fluid structures whose principal components are phospholipids, and so mixing of cells and liposomes can result in occasional fusion between the lipid bilayer of the liposome and the plasma membrane. When this happens the cloned genes can be transferred into the cytoplasm of a cell, and can thence migrate to the nucleus by passive diffusion through the pores of the nuclear envelope. Note that, in practice, cationic liposomes have been more widely used for transferring DNA into cells.

Molecular genetics of human diseases: Gene therapy

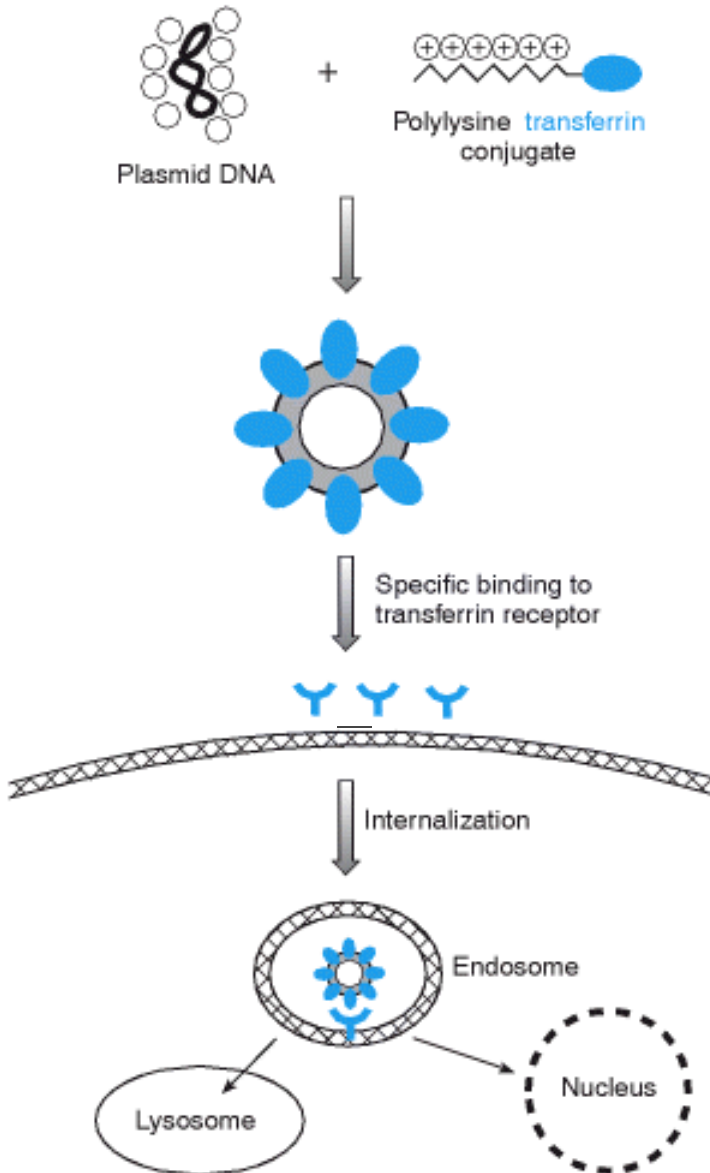

Gene transfer via the receptor-mediated endocytosis pathway. The negatively charged plasmid DNA can bind reversibly to the positively charged polylysine attached to the transferrin molecule. During this process, the DNA is condensed into a compact circular toroid with the transferrin molecules located externally and free to bind to cell surface transferrin receptors. Following initial endosome formation, a portion of the endocytosed conjugates can migrate to the nucleus, although a very significant fraction is alternatively transferred to lysosomes where the DNA is degraded. The efficiency of transfer can be increased by the further refinement of coupling an inactivated adenovirus to the DNA transferrin complex: following endocytosis and transport to lysosomes, the added adenovirus causes vesicle disruption, allowing the DNA to avoid degradation and to survive in the cytoplasm.

Molecular genetics of human diseases:

Gene therapy

Table. Properties of major methods of gene transfer used in gene therapy and their applications

Features	Oncoretroviral	Adenoviral	Adeno-associated	Lentiviral	Liposomes
Maximum insert size	7–7.5 kb	>30 kb	4.0 kb	7–7.5 kb	Unlimited
Chromosomal integration	Yes	No; episomal	Yes/No	Yes	Very low frequency
Duration of expression <i>in vivo</i>	Short	Short	Long	Long	Short
Stability	Good	Good	Good	Untested	Very good
Route of gene delivery	<i>Ex vivo</i>	<i>Ex vivo</i> and <i>in vivo</i>	<i>Ex vivo</i> and <i>in vivo</i>	<i>Ex vivo</i> and <i>in vivo</i>	<i>Ex vivo</i> and <i>in vivo</i>
Concentration (particles per ml)	>10 ⁸	>10 ¹¹	>10 ¹²	>10 ⁸	Unlimited
Ease of preparation and scale up	Pilot scale up, up to 20–50 litres	Easy to scale up	Difficult to purify; difficult to scale up	Not known	Easy to scale up
Host immunological response	Few problems	Extensive	Not known	Few problems	None
Pre-existing host immunity	Unlikely	Yes	Yes	Unlikely, except maybe AIDS patients	No
Safety concerns	Possibility of mutagenesis	Inflammatory response, toxicity	Inflammatory response, toxicity	Possibility of insertional mutagenesis	None

Molecular genetics of human diseases: Gene therapy

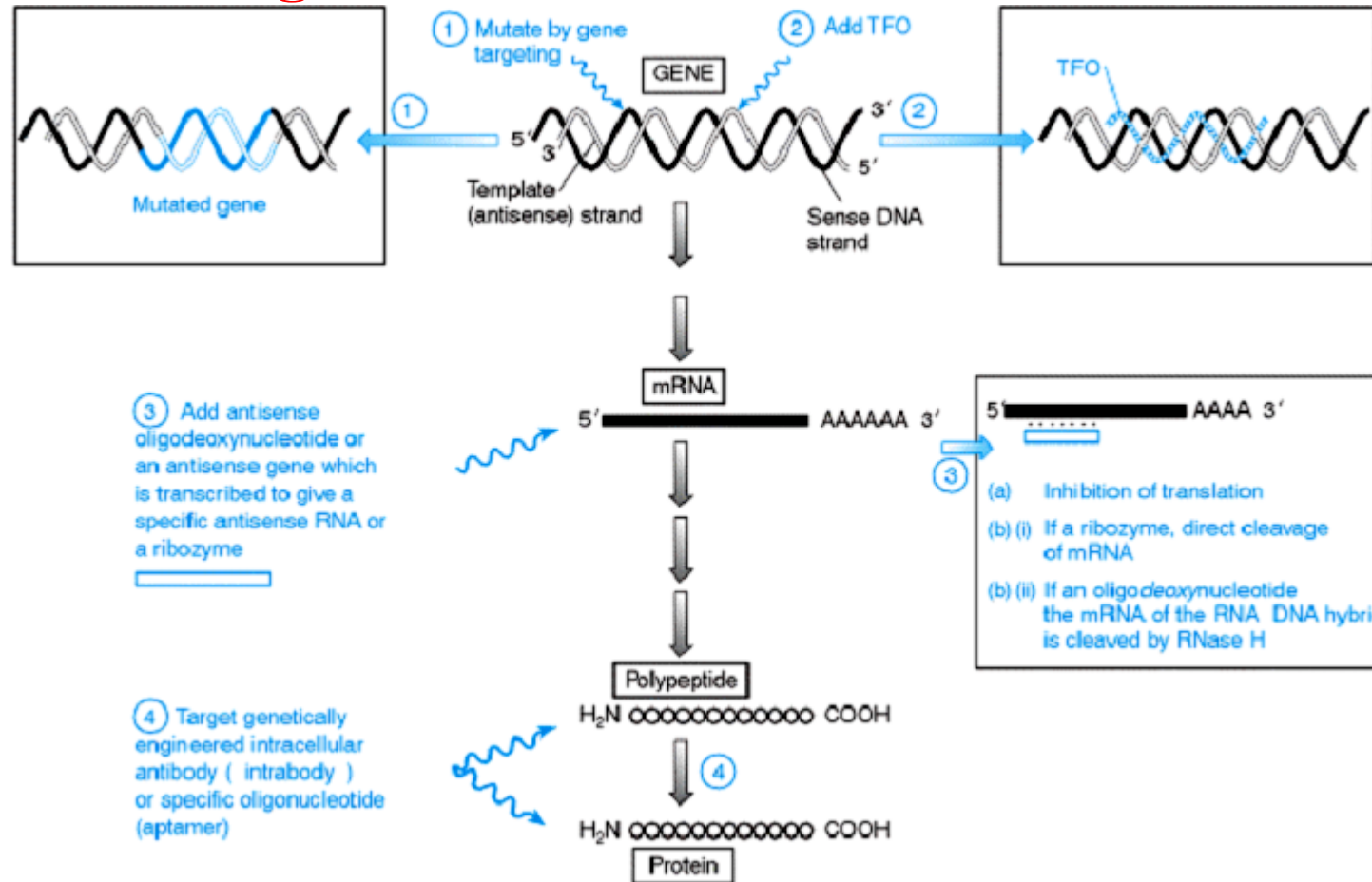

Targeted inhibition of gene expression *in vivo*. Gene therapy based on selective inhibition of a predetermined gene *in vivo* can be achieved at several levels. In principle, it is possible to mutate the gene via homologous recombination-mediated gene targeting to a nonfunctional form (1). In practice, however, it is more convenient to block expression: at the level of transcription by binding a gene-specific triplex-forming oligonucleotide (TFO) to the promoter region (2), or at the mRNA level by binding a gene-specific antisense oligonucleotide or RNA (3). In the latter case, an antisense gene is normally provided which can encode a simple antisense RNA or a ribozyme. In each case, the binding interferes with the ability of the mRNA to direct polypeptide synthesis, and may ensure its destruction: a bound oligodeoxynucleotide makes the mRNA susceptible to cleavage by RNase H, while a bound ribozyme cleaves the RNA directly. The technology for specific inhibition at the polypeptide/protein level (4) is less well developed but is possible using genes which encode intracellular antibodies or oligonucleotide aptamers which specifically bind to the polypeptide and inhibit its function.

Molecular genetics of human diseases: Gene therapy

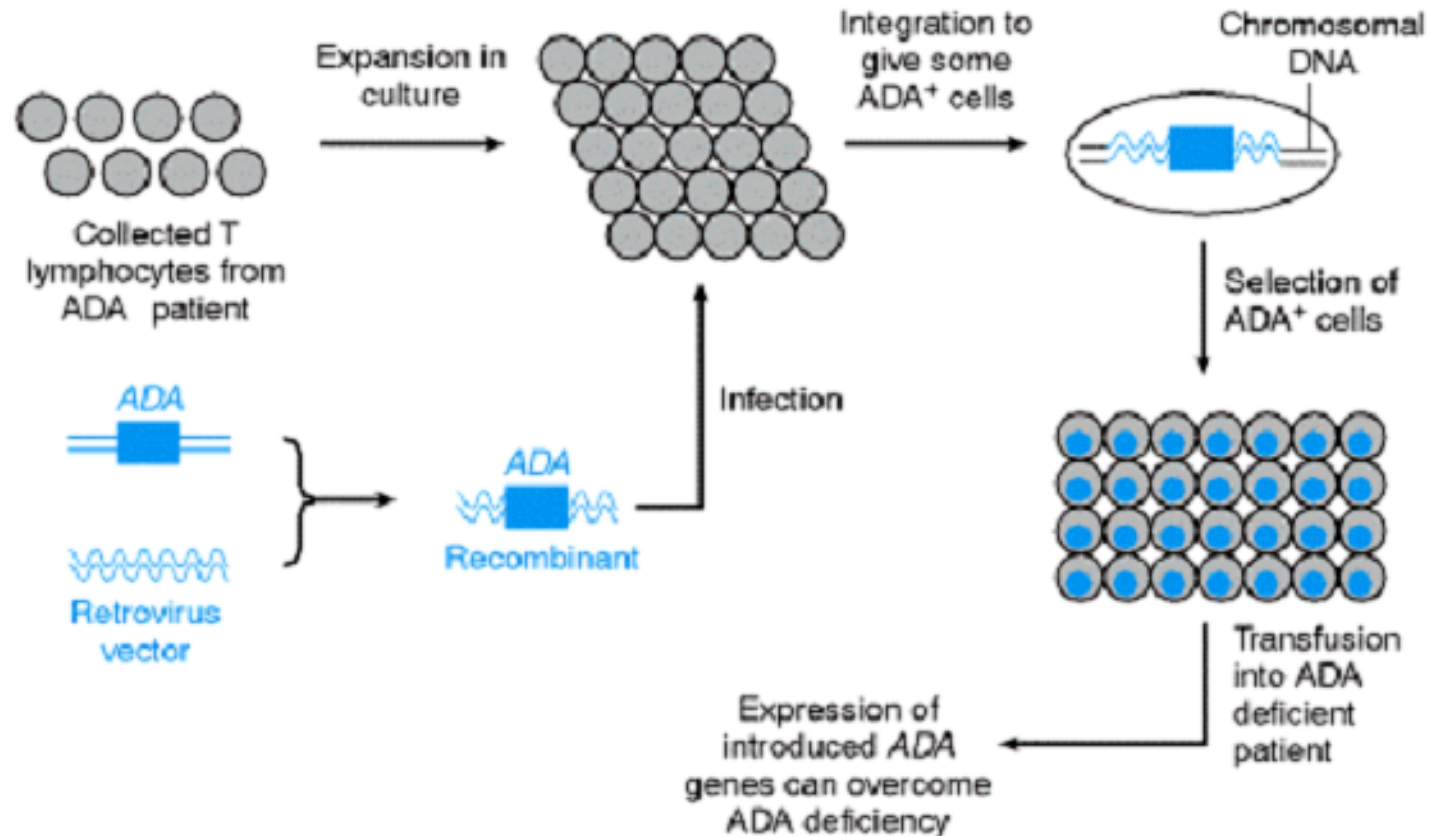

Ex vivo gene augmentation therapy for adenosine deaminase (ADA) deficiency.

Note that identification of suitably transformed cells is helped by having an appropriate selectable marker in the retrovirus vector, such as a *neo^R* gene which confers resistance to the neomycin analog G418. Following infection, the target cells can be cultured in a medium containing G418 to select for the presence of retroviral sequences, and then assayed by PCR for the presence of the inserted ADA gene. Suitable ADA⁺ cells can then be expanded in culture before being reintroduced into the patient.

Molecular genetics of human diseases:

Gene therapy

Table. Factors governing the amenability of single gene disorders to gene therapy approaches

Factor	Most amenable	Least amenable
Mode of inheritance function	Recessive: affecteds usually have no or extremely little gene product, so that even low level expression of introduced genes can have an effect	Dominant: even where the mutation is a loss-of-mutation most affected people are heterozygotes, with at least 50% of the normal gene product already present
Nature of mutation product, etc.	Loss of function: can be treated simply by gene augmentation therapy	Gain of function – novel mutant protein or toxic mutant may not be treated by simply adding normal genes. Instead, may need specifically to block expression of gene or repair genetic defect
Accessibility of target cells and amenability to cell culture	Readily accessible tissues, e.g. blood, skin, etc. Cells that can be cultured readily and reinserted in the patient permit <i>ex vivo</i> gene transfer	Tissues that are difficult to access (e.g. brain), or to derive cell cultures which can be reimplanted (thereby excluding <i>ex vivo</i> gene therapy)
Size of coding DNA	Small coding DNA size means easy to insert into vector e.g. β -globin = ~0.5 kb	Large coding DNA; may be difficult to insert into suitable vector
Control of gene expression	Loose control of gene expression with wide variation in normal expression levels, e.g. ADA expression	Tight control of gene expression, e.g. in the case of β -globin

Molecular genetics of human diseases: Gene therapy

Table. Examples of gene therapy trials for inherited disorders

Disorder	Cells altered	Gene therapy strategy
ADA deficiency	T cells and hemopoietic stem cells	<i>Ex vivo</i> GAT using recombinant retroviruses containing an <i>ADA</i> gene
Cystic fibrosis	Respiratory epithelium	<i>In vivo</i> GAT using recombinant adenoviruses or liposomes to deliver the <i>CFTR</i> gene
Familial hypercholesterolemia	Liver cells	<i>Ex vivo</i> GAT using retrovirus to deliver the LDL receptor gene (<i>LDLR</i>)
Gaucher's disease glucocerebrosidase	Hemopoietic stem cells	<i>Ex vivo</i> GAT using retroviruses to deliver the gene (<i>GBA</i>)

GAT, gene augmentation therapy.

Molecular genetics of human diseases: Gene therapy

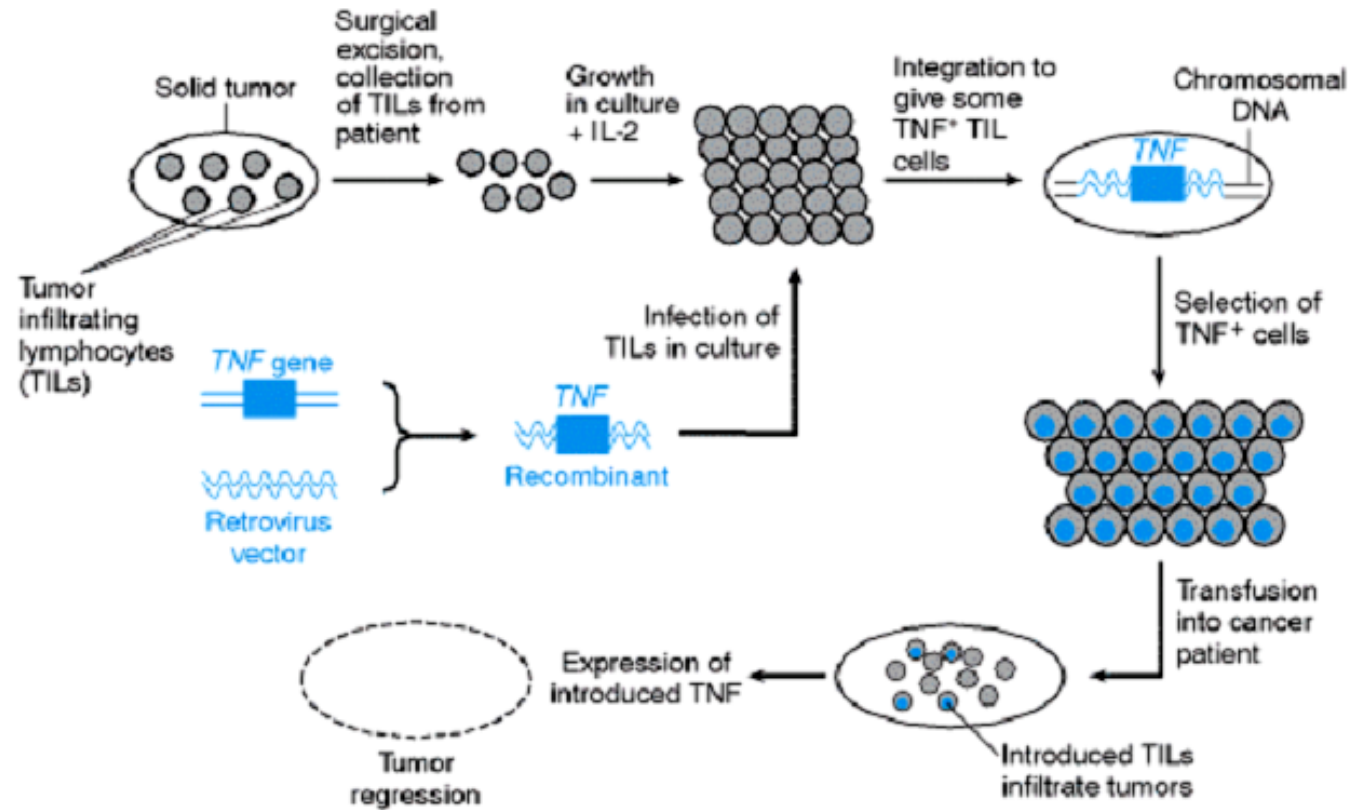

Genetic modification of cultured tumor-infiltrating lymphocytes can be used to target therapeutic genes to a solid tumor. This approach has been used in an attempt at *ex vivo* gene therapy for metastatic melanoma. The tumor-infiltrating lymphocytes (TIL) appear to be able to 'home in' to tumor deposits. In this example, they act as cellular vectors for transporting to the melanomas a retrovirus recombinant which contains a gene specifying the anti-tumor cytokine TNF- α (tumor necrosis factor- α). Problems with the efficiency of gene transfer into the TILs and down-regulation of cytokines limited the success of this approach.

Molecular genetics of human diseases: Gene therapy

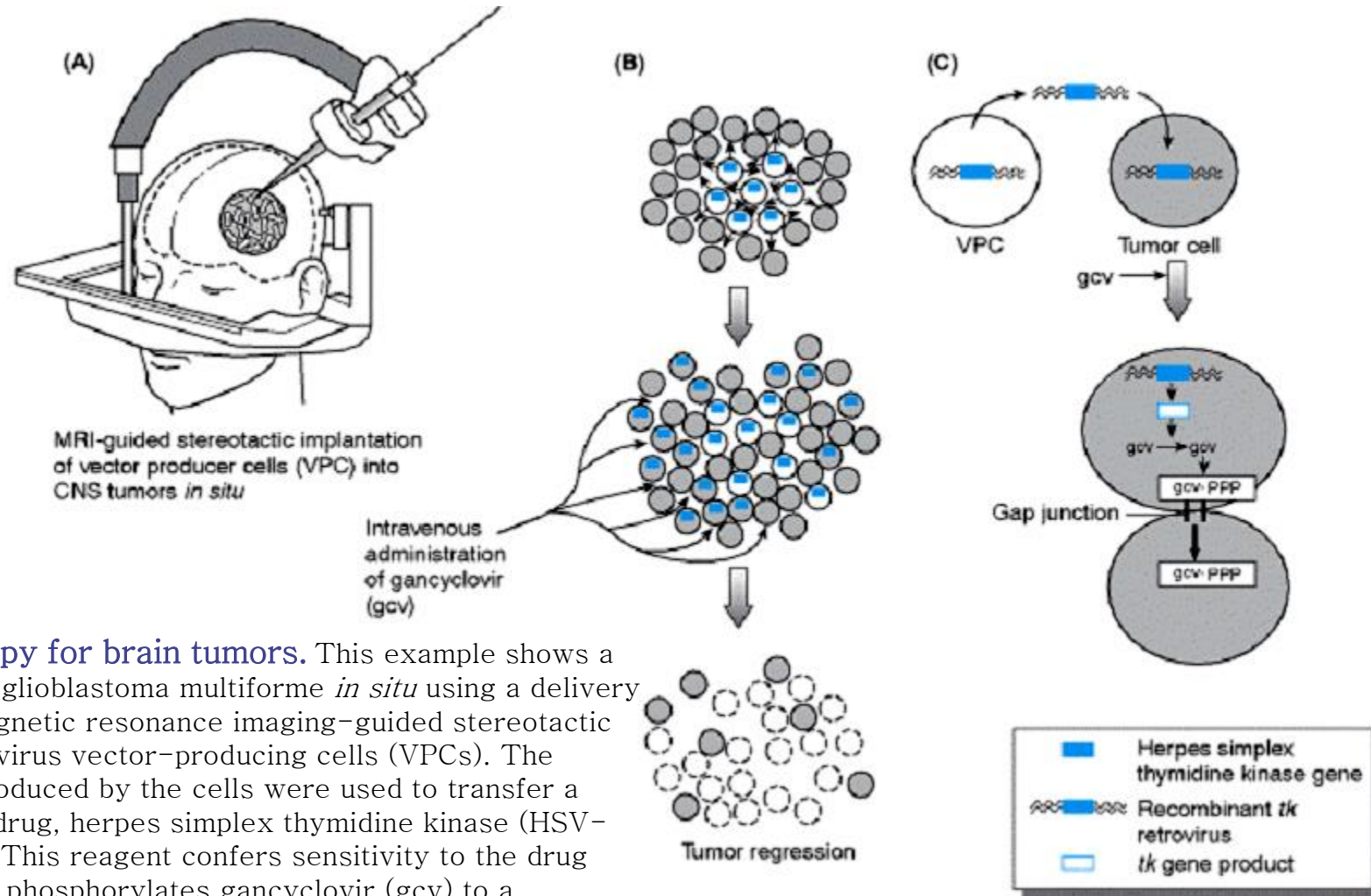

***In vivo* gene therapy for brain tumors.** This example shows a strategy for treating glioblastoma multiforme *in situ* using a delivery method based on magnetic resonance imaging-guided stereotactic implantation of retrovirus vector-producing cells (VPCs). The retroviral vectors produced by the cells were used to transfer a gene encoding a prodrug, herpes simplex thymidine kinase (HSV-tk), into tumor cells. This reagent confers sensitivity to the drug gancyclovir: HSV-tk phosphorylates gancyclovir (gcv) to a monophosphorylated form gcv-P and, thereafter, cellular kinases convert this to gancyclovir triphosphate, gcv-PPP, a potent inhibitor of DNA polymerase which causes cell death.

Because retroviruses infect only dividing cells, they infect the tumor cells, but not normal differentiated brain cells. The implanted VPCs transferred the HSV-tk gene to neighboring tumor cells, rendering them susceptible to killing following subsequent intravenous administration of gancyclovir. In addition, it was found that uninfected cells were also killed by a bystander effect: the gancyclovir triphosphate appeared to diffuse from infected cells to neighboring uninfected cells, possibly via gap junctions.

Molecular genetics of human diseases: Gene therapy

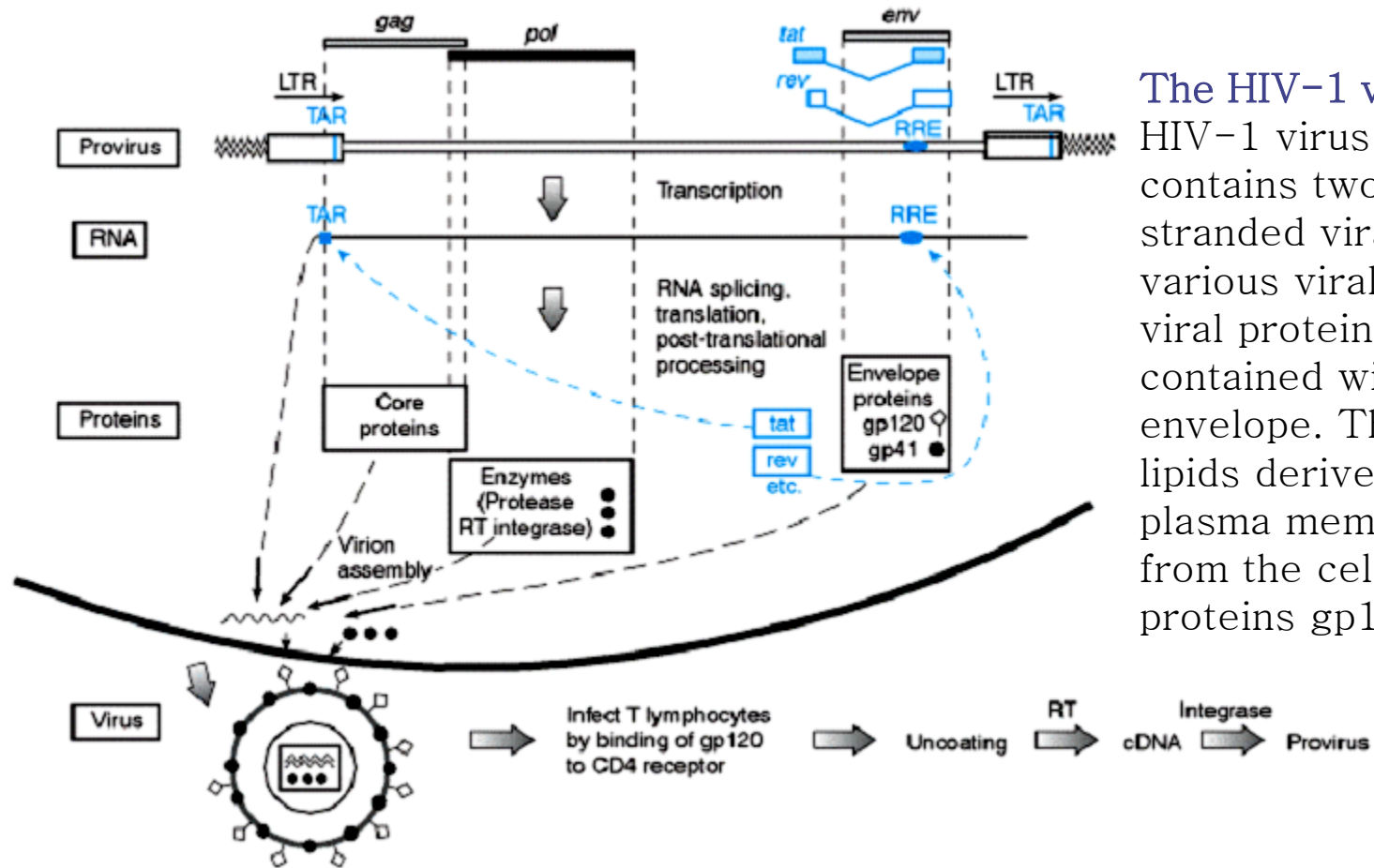

The HIV-1 virus life-cycle. The HIV-1 virus is a retrovirus which contains two identical single-stranded viral RNA molecules and various viral proteins within a viral protein core, which itself is contained within an outer envelope. The latter contains lipids derived from host cell plasma membrane during budding from the cell, plus viral coat proteins gp120 and gp41.

Penetration of HIV-1 into a T lymphocyte is effected by specific binding of the gp120 envelope protein to the CD4 receptor molecules present in the plasma membrane. After entering the cell, the viral protein coat is shed, and the viral RNA genome is converted into cDNA by viral reverse transcriptase (RT). Thereafter a viral integrase ensures integration of the viral cDNA into a host chromosome. The resulting **provirus** (see top) contains two long terminal repeats (LTRs), with transcription being initiated from within the upstream LTR. For the sake of clarity, the figure only shows some of the proteins encoded by the HIV-1 genome. In common with other retroviruses, are the *gag* (core proteins), *pol* (enzymes), and *env* (envelope proteins) genes. Tat and rev are regulatory proteins which are encoded in each case by two exons, necessitating RNA splicing. The tat protein functions by binding to a short RNA sequence at the extreme 5' end of the RNA transcript, known as TAR (*trans-acting response element*); the rev protein binds to an RNA sequence, RRE (*rev response element*), which is encoded by sequence transcribed from the *env* gene.

Molecular genetics of human diseases: Gene therapy

Table. Potential applications of gene therapy for the treatment of cancer

General approaches

Artificial killing of cancer cells

Insert a gene encoding a toxin (e.g. diphtheria A chain) or a gene conferring sensitivity to a drug (e.g. herpes simplex thymidine kinase) into tumor cells

Stimulate natural killing of cancer cells

Enhance the immunogenicity of the tumor by, for example, inserting genes encoding foreign antigens or cytokines
Increase antitumor activity of immune system cells by, for example, inserting genes that encode cytokines
Induce normal tissues to produce antitumor substances (e.g. interleukin-2, interferon)
Production of recombinant vaccines for the prevention and treatment of malignancy (e.g. BCG-expressing tumor antigens)

Protect surrounding normal tissues from effects of chemotherapy/radiotherapy

Protect tissues from the systemic toxicities of chemotherapy (e.g. multiple drug resistance type 1 gene)

Tumors resulting from oncogene activation

Selectively inhibit the expression of the oncogene

Deliver gene-specific antisense oligonucleotide or ribozyme to bind/cleave oncogene mRNA

Inhibit transcription by triple helix formation following delivery of a gene-specific oligonucleotide

Use of intracellular antibodies or oligonucleotide aptamers to specifically bind to and inactivate the oncoprotein

Tumors arising from inactivation of tumor suppressor

Gene augmentation therapy

Insert wild-type tumor suppressor gene

Molecular genetics of human diseases: Gene therapy

Table. Examples of cancer gene therapy trials

Disorder	Cells altered	Gene therapy strategy
Brain tumors	Tumor cells <i>in vivo</i>	Implanting of murine fibroblasts containing recombinant retroviruses to infect brain cells and ultimately deliver HSV-tk gene
Breast cancer	Tumor cells <i>ex vivo</i>	DNA transfection to deliver antisense <i>IGF1</i> Retroviruses to deliver <i>MDR1</i> gene Retroviruses to deliver <i>IL4</i> gene
	Hematopoietic stem cells <i>ex vivo</i>	
	Fibroblasts <i>ex vivo</i>	
Colorectal cancer	Hematopoietic stem <i>ex vivo</i>	Retroviruses to deliver <i>MDR1</i> gene
	Tumor cells <i>in vivo</i>	Liposomes to deliver genes encoding HLA-B7 and β_2 -microglobulin
Malignant melanoma	Tumor cells <i>ex vivo</i>	Retroviruses to deliver <i>IL2</i> or <i>TNF</i> gene
	Fibroblasts <i>ex vivo</i>	Retroviruses to deliver <i>IL2</i> or <i>IL4</i> genes
	Tumor cells <i>in vivo</i>	Liposomes to deliver genes encoding HLA-B7 and β_2 -microglobulin
Myelogenous leukemia	Tumor cells <i>ex vivo</i>	Retroviruses to deliver <i>IL2</i> gene
	T cells/tumor cells <i>ex vivo</i>	Retroviruses to deliver <i>IL4</i> gene
Neuroblastoma	Tumor cells	Retroviruses to deliver <i>TNFA</i> gene
	Tumor cells	Retroviruses to deliver HSV-tk gene
Non-small cell lung cancer	Tumor cells <i>in vivo</i>	Retroviruses to deliver antisense <i>KRAS</i>
Ovarian cancer	Tumor cells <i>in vivo</i>	Retroviruses to deliver wild-type TP53 gene
	Tumor cells <i>ex vivo</i>	Retroviruses to deliver HSV-tk gene
Renal cell carcinoma	Hematopoietic stem cells <i>ex vivo</i>	Retroviruses to deliver <i>MDR1</i> gene
	Tumor cells <i>ex vivo</i>	Retroviruses to deliver <i>IL2</i> or TNF genes
Small cell lung cancer	Fibroblasts <i>ex vivo</i>	Retroviruses to deliver <i>IL4</i> gene
Solid tumors	Tumor cells <i>ex vivo</i>	DNA transfection to deliver <i>IL2</i> gene
	Tumor cells <i>in vivo</i>	Liposomes to deliver genes encoding HLA-B7 and β_2 -microglobulin